

# Microwave Oven

# Use and Care Guide

The Roper logo consists of the word "ROPER" in a bold, sans-serif font. Above and below the text are two thick, horizontal, slightly curved lines that frame the brand name.

**Appliances**  
**MFE 14XW**

## **Thank you for choosing a Roper appliance**

This Use and Care Guide will help you operate and maintain your new, qualitybuilt Roper microwave oven. Keep this Use and Care Guide in a safe place for future reference.

## **Complete and mail the Product Registration Card**

This card enters your warranty into our warranty system that insures efficient claim processing, can be used as a proof of purchase for insurance claims and helps Roper to contact you immediately in the unlikely event of a product-safety recall.

## **Please remember**

It is your responsibility to be sure that your microwave oven:

- Has been properly installed and leveled where it is protected from the elements and on a surface strong enough to support its weight. (See the Installation Instructions.)  
**The microwave oven should be at a temperature above 50°F (10°C) for proper operation.**
- Has been properly connected to electrical supply and grounded. (See the Installation Instructions.)
- Is not used by children or anyone unable to operate it properly.
- Is properly maintained.
- Is used only for jobs expected of a home microwave oven.

## **PRECAUTIONS TO AVOID POSSIBLE EXPOSURE TO EXCESSIVE MICROWAVE ENERGY . . .**

**DO NOT** attempt to operate this oven with the door open since open-door operation can result in harmful exposure to microwave energy. It is important not to defeat or tamper with the safety interlocks.

**DO NOT** place any object between the oven front face and the door or allow soil or cleaner residue to accumulate on sealing surfaces.

**DO NOT** operate the oven if it is damaged. It is particularly important that the oven door close properly and that there is no damage to the:

- (1) Door (bent),
- (2) Hinges and latches (broken or loosened),
- (3) Door seals and sealing surfaces.

**DO NOT** operate the microwave oven if the door window is broken.

The microwave oven should be checked for microwave leakage by qualified service personnel after a repair is made.

The oven should not be adjusted or repaired by anyone except properly qualified service personnel.

**DO NOT** operate the microwave oven with the outer cabinet removed.

# IMPORTANT SAFETY INSTRUCTIONS

Microwave ovens have been thoroughly tested for safe and efficient operation. However, as with any appliance, there are special installation and safety precautions which must be followed to ensure safe and satisfactory operation and prevent damage to the unit.

## WARNING

To reduce the risk of fire, electrical shock, injury to persons or damage when using the microwave oven, follow basic precautions, including the following:

- Read all instructions before using appliance.
- Read and follow the specific "Precautions To Avoid Possible Exposure To Excessive Microwave Energy" found on page 2.
- This appliance must be grounded. Connect only to properly grounded outlet. See Grounding Instructions found on page 5.
- Install or locate this appliance only in accordance with the provided Installation Instructions found on page 6.
- Some products such as whole eggs and sealed containers—for example, closed glass jars—may explode and should not be heated in this oven.
- Use this appliance only for its intended use as described in this manual.
- As with any appliance, close supervision is necessary when used by children.
- Do not operate this appliance if it has a damaged cord or plug, if it is not working properly, or if it has been damaged or dropped. Electrical shock, fire or other hazards may result.
- This appliance should be serviced only by qualified service personnel. Call an authorized Roper<sup>SM</sup> service company for examination, repair or adjustment.
- Do not cover or block any opening on the appliance. Fire may result.
- Do not use outdoors. Damage to the oven or electrical shock may result.
- Do not immerse cord or plug in water. Electrical shock may result.
- Keep cord away from heated surfaces. Electrical shock may result.
- Do not let cord hang over edge of table or counter. Electrical shock may result.
- Follow door surface and interior cleaning instructions on page 20.
- To reduce the risk of fire in the oven cavity:
  - Do not overcook food. Carefully attend appliance if paper, plastic, or other combustible materials are placed inside the oven to facilitate cooking. Paper can char or burn, and some plastics can melt if used when heating foods.
  - Do not deep fry in oven.
  - **Test dinnerware or cookware before using.** See pages 18 and 19. Some dishes (melamine, Centura<sup>®</sup>, etc.) absorb microwave energy, becoming too hot to handle and slowing cooking times. Remove wire twist-ties from paper or plastic bags before placing bag in oven. Cooking in metal containers can damage the oven. So can containers with hidden metal (twist-ties, foil lining, staples, metallic glaze or trim).
  - If materials inside the oven should ignite, keep oven door closed, turn oven off, and disconnect the power cord, or shut off power at the fuse or circuit breaker panel.
- Do not heat, store or use flammable materials in or near the oven. Fumes can create a fire hazard or explosion.
- Read and follow "SAFETY PRECAUTIONS" on page 20 and "OTHER HELPFUL INSTRUCTIONS" on page 23.

## SAVE THESE INSTRUCTIONS

# TABLE OF CONTENTS

---

<b>INSTALLATION</b> .....	5
<b>FEATURES</b> .....	7
<b>CONTROL PANEL</b> .....	8
<b>OPERATING INSTRUCTIONS</b>	
1. SETTING TIME OF DAY .....	9
2. HI-POWER/MULTI-POWER COOKING .....	10
3. MULTI-STAGE COOKING .....	11
4. DELAY START COOKING .....	12
5. HOLD WARM .....	13
6. AUTOMATIC DEFROST COOKING .....	14
7. AUTOMATIC WEIGHT DEFROST COOKING .....	15
8. PROGRAMMING NEW RECIPES .....	17
<b>INTRODUCTION TO MICROWAVE COOKING</b> .....	18
<b>CARE OF YOUR MICROWAVE OVEN</b> .....	20
<b>SAFETY PRECAUTIONS</b> .....	20
<b>QUESTIONS AND ANSWERS</b> .....	22
<b>OTHER HELPFUL INSTRUCTIONS</b> .....	23
<b>TECHNICAL SPECIFICATIONS</b> .....	24
<b>WARRANTY</b> .....	BACK COVER

# INSTALLATION

## A. EXAMINE OVEN

Empty the microwave oven and clean inside it with a soft, damp cloth. Check for damage such as misaligned door, damage around the door or dents inside the oven or on the exterior. If there is any damage, please do not operate the unit until it has been checked by an authorized service technician and any repairs made.

## B. GROUNDING INSTRUCTIONS:

### ⚠ WARNING

#### Electrical Shock Hazard

Improper use of the grounding plug can result in a risk of electrical shock. **DO NOT, UNDER ANY CIRCUMSTANCES, REMOVE THE POWER SUPPLY CORD GROUNDING PRONG.**

#### PREFERRED METHOD

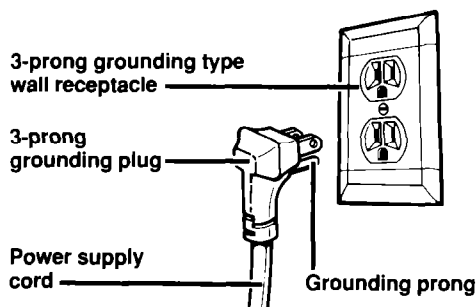

ENSURE PROPER GROUND EXISTS  
BEFORE USE

For your personal safety, this appliance must be grounded. In the event of an electrical short circuit, grounding reduces the risk of electrical shock by providing an escape wire for the electric current. This appliance is equipped with a polarized 3-prong grounding plug. It must be plugged into a correctly polarized mating 3-prong grounding type wall receptacle, properly installed and grounded in accordance with local codes and ordinances. If a mating wall receptacle is not available or if you are not sure if the wall receptacle is properly grounded and polarized, have it checked by a qualified electrician.

It is the personal responsibility and obligation of the customer to have a properly grounded and correctly polarized 3-prong wall receptacle installed by a qualified electrician.

Consult a qualified electrician if the grounding instructions are not completely understood, or if doubt exists as to whether the appliance is properly grounded.

**It is not recommended to use an extension cord with your microwave oven, but if you find it necessary to do so temporarily (until a properly grounded and polarized 3-prong receptacle is installed), use only a heavy duty UL listed 3-wire grounding type extension cord containing three 16-gauge (minimum) copper wires.** It must not be longer than 10 feet (cords longer than 10 feet may affect the cooking performance of your microwave oven). The plug on the extension cord must fit into a 3-prong grounding type wall receptacle (as shown on this page) and the receptacle end of the extension cord must accept the 3-prong grounding plug of the microwave oven. The marked rating of the extension cord should be equal to or greater than the electrical rating of the appliance.

## C. CIRCUITS

**Observe all governing codes and ordinances.** A 120 Volt, 60Hz, AC only, 15 or 20 amp fused electrical supply is required. (Time-delay fuse is recommended.) It is recommended that a separate circuit serving only this appliance be provided.

## D. VOLTAGE WARNING

The voltage used at the wall receptacle must be the same as specified on the oven serial plate located on the back or on the side of the control panel of the oven. Use of a higher voltage is dangerous and may result in a fire or other type of accident causing oven damage. Low voltage will cause slow cooking. In case your microwave oven does not perform normal operations in accordance with AC power source and voltage, remove the power cord and then insert it again.

## E. LOCATION OF THE OVEN

Your microwave oven can easily be placed in your kitchen, family room or any other room in your home. Place the oven on a flat surface such as a kitchen counter top or a specially-designed microwave oven cart. **(The control side of the unit is the heavy side. Use care when handling.)** The weight of the oven is approximately 40 lbs. (18 kg). Do not place oven above a gas or electric range. Free air flow around the oven is important. The microwave oven should be placed three inches or more away from the edge of the countertop or cart to avoid accidental tipping of the oven.

### **⚠ CAUTION**

**Do not install the oven next to a conventional surface unit or in any area where excessive heat and steam are generated. This could damage the outside of the cabinet.**

## F. DO NOT BLOCK VENTS

All air vents should be kept clear during cooking. If air vents are covered during oven operation, the oven may overheat. In this case a sensitive thermal safety device automatically turns the oven off. The oven will be inoperable until it has cooled sufficiently. Make sure the microwave oven legs are in place to ensure proper air flow.

## G. TEST THE OVEN

To test the oven, plug it into the proper electrical outlet. Put about one cup (250 mL) of cold water in a glass container in the oven. Close the door. Make sure it latches. Follow the directions on page 10 to set the oven to cook for 2 minutes. When the time is up, the water should be heated.

## H. USE OVEN PROPERLY

**This microwave oven is designed for use in the household only and must not be used for commercial purposes.**

**Do not** remove the door, control panel or cabinet at any time. The unit is equipped with high voltage and should not be serviced unless by an authorized service technician.

**For most accurate programming of the electronic units**, touch the center of each pad securely. Do not touch several pads at one time or touch in between pads. A tone should be heard with each touch when pad is touched correctly.

# FEATURES

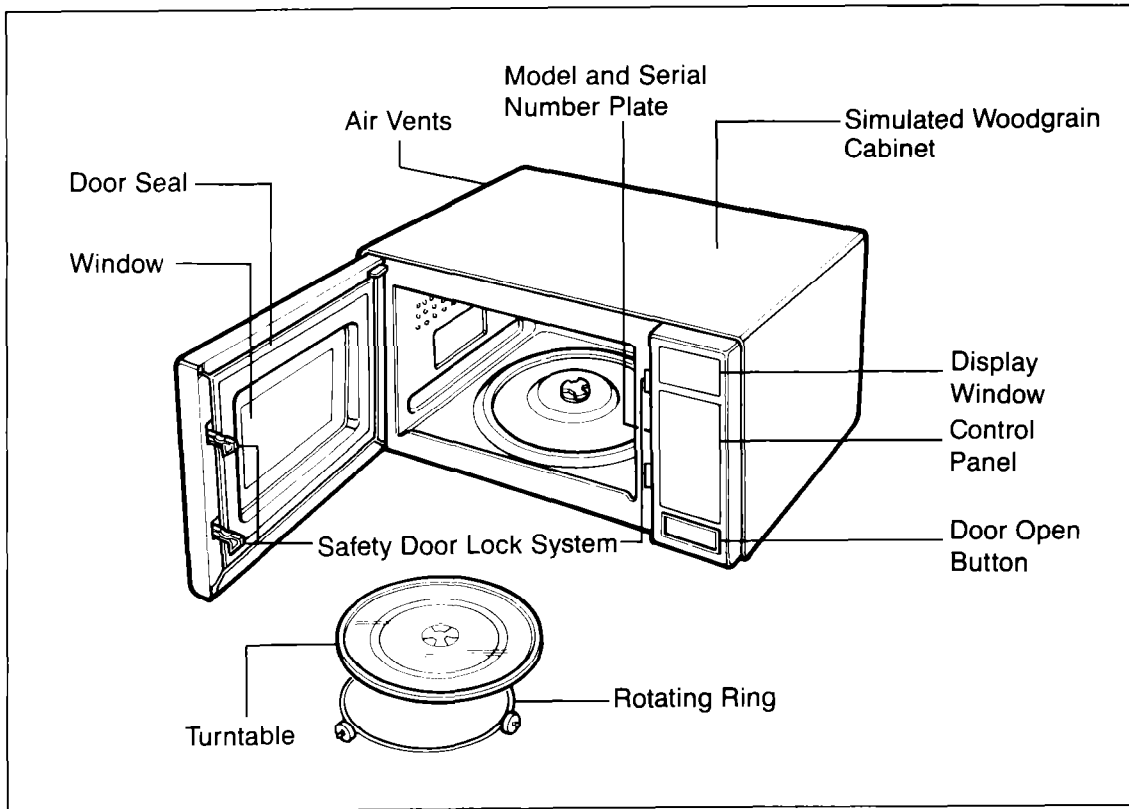

Remove your Microwave Oven and all material from the shipping carton.  
Your oven will be packed with the following material:

Turntable .....	1
Owner's Manual .....	1
Cooking Guide .....	1
Rotating Ring .....	1

# CONTROL PANEL

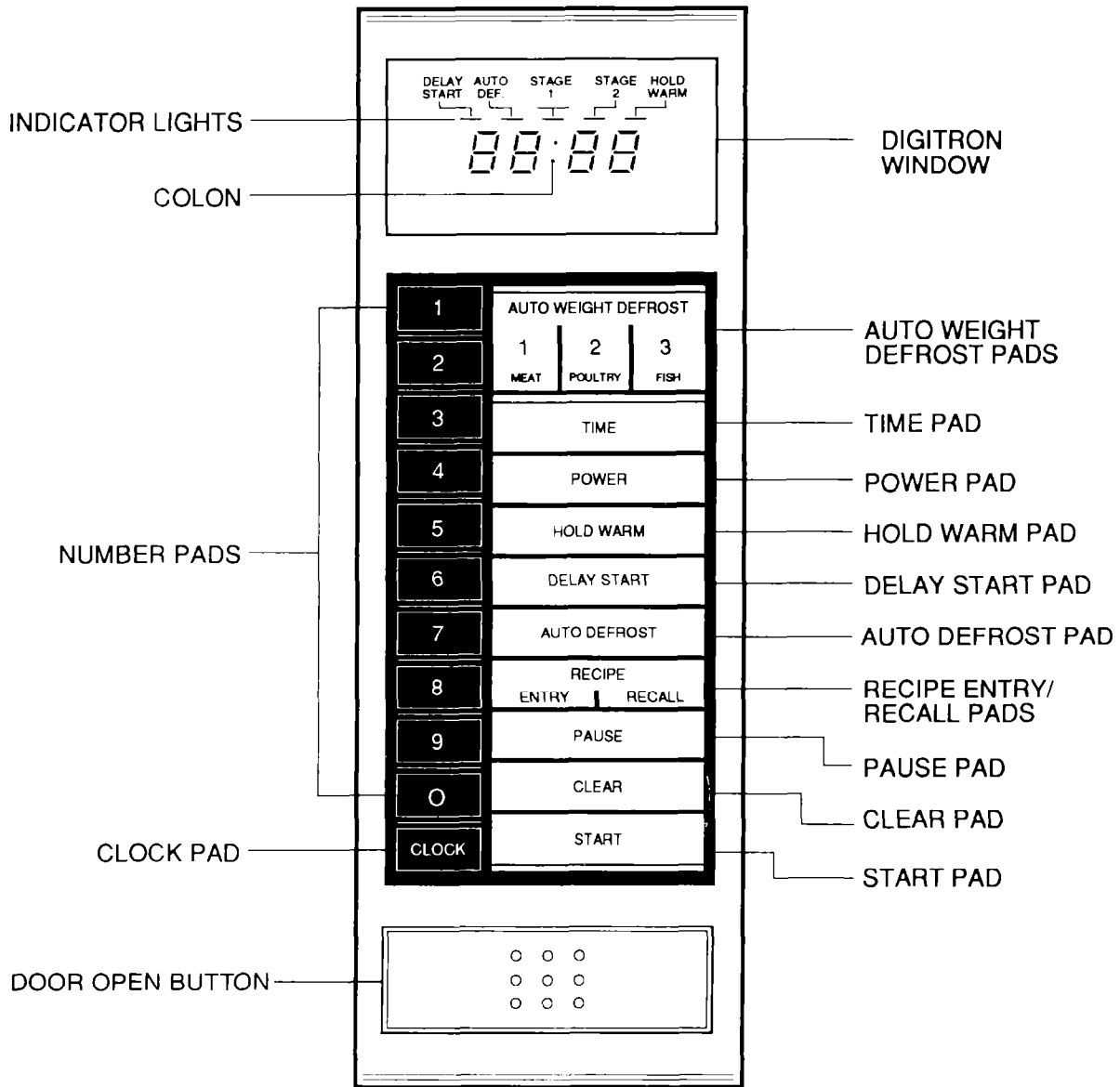

**NOTE:** To enter a setting, touch a word or number pad. A beep sounds when a pad on the control panel is touched to indicate a setting has been entered.



# OPERATING INSTRUCTIONS

## 1. SETTING TIME OF DAY

To set the TIME OF DAY, enter the correct time of day 4:30.

STEP	KEY BOARD	DISPLAY WINDOW	REMARKS
1. Plug the power cord into an electrical outlet.			A "0" will show in the display and the colon will blink.
2. Touch CLOCK.			A "0" will show without the colon.
3. Enter the correct time of day.			The time will be set.
4. Touch CLOCK again.			The colon will reappear and the clock will be set.

### NOTE:

This is a 12 hour clock.

will appear in the display if you attempt to enter an incorrect clock time, for example 3:78 or 14:02.



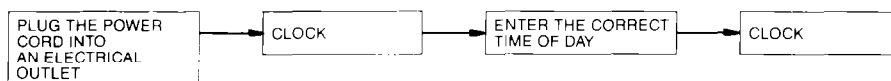







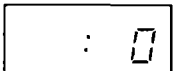

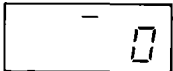
### OPERATION SUMMARY

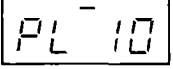

## 2. HI-POWER/MULTI-POWER COOKING

HI-POWER COOKING gives the highest cooking power possible with your microwave oven. It is the recommended setting for cooking foods with high moisture content or for cooking foods that need fast cooking to maintain their natural flavor and texture. Many foods need slower cooking (at less than HI power) in order to give you the best results. In addition to HI-POWER cooking there are nine multi-power settings. Consult a reliable cookbook for a recommended power setting for the food being cooked.

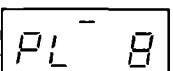
**EXAMPLE:** If you want to cook food on 80% Power (PL 8) for 5 minutes 30 seconds:

STEP	KEY BOARD	DISPLAY WINDOW	REMARKS
1. Touch CLEAR.			Erases all previous settings except time of day and recipe entry program.
2. Touch TIME.			"STAGE 1" light will blink.
3. Touch the correct numbers on the control panel to set the cooking time.	  		The set time will show in the display.
4. Touch POWER.			
5. Touch 8.			
6. Touch START.			The oven begins to cook and the time will begin to count down in the display. Two short and one long tone will sound and the word "End" will show in the display when the 5 minutes 30 seconds is over.

### NOTE:

If you do not select the power level, the oven will operate at power level HIGH. To set HI-POWER cooking, skip steps 4-5 above.

### OPERATION SUMMARY

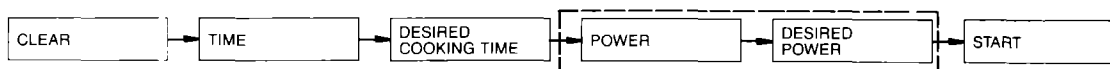









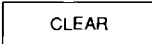

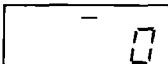

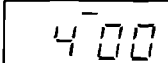
Skip these steps to set HI-POWER COOKING.

### 3. MULTI-STAGE COOKING

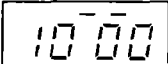
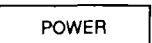
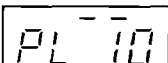
MULTI-STAGE cooking allows you to set the oven in a first stage at a certain power level for a chosen time and then in a second and a third stage at a different power level for a chosen time. The cooking process can be set for three memory stages when AUTO WEIGHT DEFROST is included as the first stage. The stages are set before cooking and will sequence automatically after START is touched.

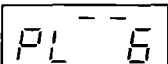
**EXAMPLE:** In preparing rice, place 1 cup of rice and 2½ cups of hot water in a 2-quart glass casserole, use a first stage of 4 minutes at the HI-POWER followed by a second stage of 10 minutes at power 6.

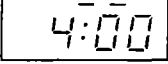
STEP	KEY BOARD	DISPLAY WINDOW	REMARKS
1. Touch CLEAR.			Erases all previous settings except time of day and recipe entry program.
2. Touch TIME.			"STAGE 1" light will blink.
3. Set 4 minutes by touching "4, 0, and 0".			The first stage has been set.
4. Touch TIME.			"STAGE 2" light will blink.
5. Set 10 minutes by touching "1, 0, 0 and 0".			
6. Touch POWER.			
7. Touch number 6.			The second stage has been set.
8. Touch START.			The first stage will begin 4:00 will show in the display.

**NOTE:**

Some recipes require stirring, turning over, adding or removing foods between stages. To set the oven to stop between stages, touch PAUSE after setting the first stage. If pause is set, the oven will automatically stop and the word "PAUS" will flash in the display window. After the pause, to restart the oven, touch START.



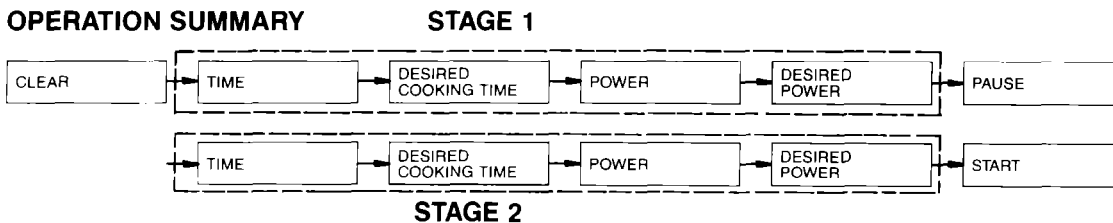







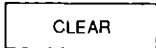
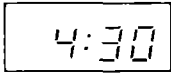
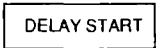

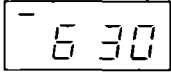
**OPERATION SUMMARY**

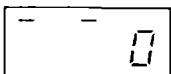

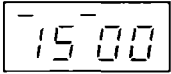
## 4. DELAY START COOKING

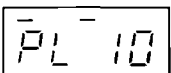
DEALY START cooking can be done by starting the cooking automatically at a preset delay time for the chosen cooking time.

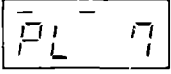
**EXAMPLE:** If you want to start at 6:30. (Current time of day is 4:30.)

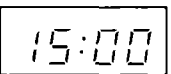
STEP	KEY BOARD	DISPLAY WINDOW	REMARKS
1. Touch CLEAR.			
2. Touch DELAY START.			"DELAY START" light will blink.
3. Touch numbers for the time of day to start cooking.			A preset delay time must be less than 12 hours.
4. Touch TIME.			"STAGE 1" light will blink.
5. Touch numbers for cooking time.			
6. Touch POWER.			
7. Touch number for desired power.			
8. Touch START.			The present time of day will show in the display. As soon as the clock shows the preset cook start time, the oven will start cooking and the cooking time will count down in the display.

### NOTE:

1. DELAY START cooking must always be used after TIME OF DAY is set.
2. If you want to change the delay start time and recipe during DELAY START operation, touch CLEAR, and touch DELAY START again, and then follow the above steps numbered 3-8.

## ⚠ WARNING

To avoid sickness and food waste when using delay start:

- Do not use foods that will spoil while waiting for cooking to start, such as dishes with milk or eggs, cream soups, and cooked meats or fish. Any food that has to wait for cooking to start should be very cold or frozen before it is put in the oven. **MOST UNFROZEN FOODS SHOULD NEVER STAND MORE THAN TWO HOURS BEFORE COOKING STARTS.**
- Do not use foods containing baking powder or yeast when using delay start. They will not rise properly.
- Do not allow food to remain in oven for more than two hours after end of cooking cycle.

### OPERATION SUMMARY

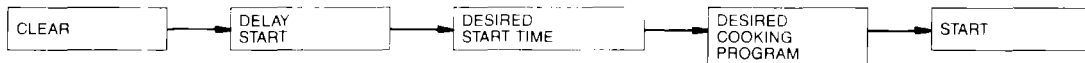

## 5. HOLD WARM

Your oven has a HOLD WARM feature that keeps the food warm after the cooking is done.

STEP	KEY BOARD	DISPLAY WINDOW	REMARKS
1. Touch CLEAR.	<div style="border: 1px solid black; padding: 2px; width: fit-content; margin: 0 auto;">CLEAR</div>	<div style="border: 1px solid black; padding: 2px; width: fit-content; margin: 0 auto;">: 0</div>	
2. Touch HOLD WARM.	<div style="border: 1px solid black; padding: 2px; width: fit-content; margin: 0 auto;">HOLD WARM</div>	<div style="border: 1px solid black; padding: 2px; width: fit-content; margin: 0 auto;">Ho ld</div>	HOLD WARM operates for 60 minutes unless the door is opened or CLEAR is touched.  When the cooking cycle is over, the oven will switch into HOLD WARM to keep the food warm. The Hold Warm light will blink and the display will show "Hold". The cooking control setting changes to power level 1 (10% power).
3. Touch START.	<div style="border: 1px solid black; padding: 2px; width: fit-content; margin: 0 auto;">START</div>	<div style="border: 1px solid black; padding: 2px; width: fit-content; margin: 0 auto;">Ho ld</div>	

### NOTE:

HOLD WARM will continue for up to 60 minutes if the door has not been opened or CLEAR has not been touched. At this time, "End" will show briefly in the display. "End" then will disappear with two short and one long tones.







### OPERATION SUMMARY

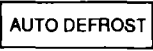

## 6. AUTOMATIC DEFROST COOKING

At this mode, output power is controlled automatically by the input time. During the first 10% of the input time, the output power will be 70%. During the second 40% of the input time, the output power will be 30%. And during the final 50% of the input time, the output will be 0%.

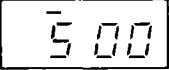
**EXAMPLE:** If you want to defrost one pound of hot dog, you can use programmed Defrost pad for 5 minutes.

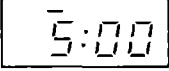
STEP	KEY BOARD	DISPLAY WINDOW	REMARKS
1. Touch CLEAR.			Erases all previous setting except time of day and recipe entry cooking.
2. Touch AUTO DEFROST.			"AUTO DEF." will blink in the display.
3. Touch numbers for the desired defrosting time. (5 min.)			"500" will show in the display.
4. Touch START.			The oven will begin to defrost and the display will show the time counting down.  Two short and one long tone will be heard and the word "End" will show in the display when setting time is over.

### NOTE:

- Each defrost sequence consists of the three segments (three different power control). After the first segment is complete, five tones will sound and the oven will continue to defrost. At this time, open the door and turn the food over. Close the oven door and touch START. The oven will automatically continue to count down the amount of time left on the timer.
- Auto defrost time can be set up to 99 min. 99 sec.

### OPERATION SUMMARY

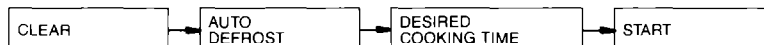

## 7. AUTOMATIC WEIGHT DEFROST COOKING







Three defrost sequences are preset in the oven. The defrost features provide you with the best defrosting method for frozen foods. A cookbook will show you which defrost sequence is recommended for the food you are defrosting.

### AUTO WEIGHT DEFROST SEQUENCE LIST

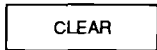
SEQUENCE	FOOD	MIN./MAX. FOOD
MEAT	<ul style="list-style-type: none"> <li>• BEEF ..... Ground beef, Round Steak, Cubes for stew, Tenderloin steak, Pot roast, Rib roast, Rump roast, Chuck Roast</li> <li>• LAMB ..... Chops (1-inch thick), Rolled roast.</li> <li>• PORK ..... Chops (½-inch thick), Hot dogs, Spareribs, Country-style ribs, Rolled roast, Sausage</li> <li>• VEAL ..... Cutlets (1 lb., ½-inch thick)</li> </ul>	0.1/9.9 lbs.
POULTRY	<ul style="list-style-type: none"> <li>• CHICKEN ..... Whole (under 4 lbs.), Cut up Breasts (boneless)</li> <li>• CORNISH HENS ... Whole</li> <li>• TURKEY ..... Breast (under 6 lbs.)</li> </ul>	0.1/9.9 lbs.
FISH	<ul style="list-style-type: none"> <li>• FISH ..... Fillets, Steaks, Whole</li> <li>• SHELLFISH ..... Crabmeat, Lobster tails, Shrimp, Scallops</li> </ul>	0.1/9.9 lbs.

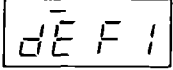
- The benefit of this Auto Weight Defrost feature is automatic setting and control of defrosting, but just like conventional defrosting you must check the foods during the defrosting time.
- For best results, remove fish, shellfish, meat and poultry from its original paper or plastic closed package (wrapper). Otherwise, the wrap will hold steam and juice closed to the foods which can cause the outer surface of the foods to cook.
- When it is difficult to remove the wrap from the foods, defrost the wrapped food for stage 1 of the defrost time. Remove the foods from the oven at the tone and remove the wrap and metal twist ties from food.
- Place food in a shallow glass baking dish or microwave roasting rack to catch drippings.
- Food should still be somewhat icy in the center when removed from the oven.

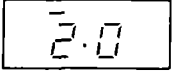
**EXAMPLE:** If you want to defrost 2 pounds of Ground Beef.

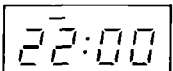
STEP	KEY BOARD	DISPLAY WINDOW	REMARKS
1. Touch CLEAR.			
2. Touch MEAT.			"AUTO DEF." light will show in the display.
3. Enter weight of the ground beef by touching "2" and "0".	 		"2.0" will show in the display.
4. Touch START.			The oven will begin the defrosting cycle you selected and display will show the total defrosting time counting down. At the end of the required time, two short and one long tone will sound and "End" will show in the display. The oven shuts off automatically.

**NOTE:**

For more efficient defrosting results, your microwave oven controls three different output powers automatically during the defrost cycle.



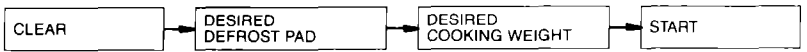



**OPERATION SUMMARY**



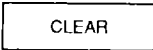

## 8. PROGRAMMING NEW RECIPES

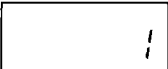
You can program 4 favorite recipes (#1-4).

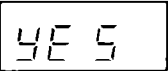
STEP	KEY BOARD	DISPLAY WINDOW	REMARKS
1. Touch CLEAR.			Erases all previous settings except time of day and recipe entry program.
2. Set the desired cooking program.			
3. Touch RECIPE ENTRY/RECALL.			"0" will show in the display.
4. Touch number for new recipe (#1-4). ex: If you want to select number 1, touch "1".			The display shows "1".
5. Touch RECIPE ENTRY/RECALL.			"YES" will show in the display. New recipe is now programmed.

### NOTE:

A recipe which has been stored in this manner can be changed to a new recipe. If you want to change to a new recipe, the previously stored recipe is erased when a new recipe is entered over the old recipe. Make a list of the recipe numbers and their recipes which are stored in this manner so that you can have easy reference for a later time.

### HOW TO CALL UP A PRESET NEW RECIPE

1. Touch CLEAR.
2. Touch RECIPE ENTRY/RECALL.
3. Touch suitable number for preset new recipe. (#1-4)
4. Touch START.

### OPERATION SUMMARY



# INTRODUCTION TO MICROWAVE COOKING

## HOW YOUR MICROWAVE OVEN WORKS

Microwaves are a form of energy similar to radio and television waves. Your microwave oven is constructed in such a way as to take advantage of microwave energy. Electricity is converted into microwave energy by the magnetron tube, and microwaves are then sent into the cooking area through a plate at the right side of the oven. Microwaves reflect off the metal walls of the oven. Since microwaves do not penetrate metal, cooking utensils made of metal are not used for cooking in the microwave. The microwaves can however be transmitted through glass, paper, wicker and microwavable cooking dishes. Microwaves do not heat the cookware, though vessels will eventually feel hot from the heat generated by the food. Microwaves are attracted to the moisture in foods and cause the molecules to vibrate, 2,450 million times per second. As the molecules vibrate, they rub against each other, producing friction. This friction, in turn, causes the food to get hot. If you have trouble imagining how this is possible, just think how hot your hands would get if you rubbed your palms together 2,450 million times per second!

**A very safe appliance:** Your microwave oven is one of the safest of all home appliances. When the door is opened, the oven automatically stops producing microwaves. By the time microwave energy has been converted into heat in the process of making food hot, the microwaves have completely dissipated.

**Factors affecting cooking times:** The cooking times given in the recipes in this guide are approximate rather than exact. Many factors affect cooking times. The temperature of ingredients used in a recipe makes a big difference in cooking time. For example, a cake made with ice-cold butter, milk, and eggs will take considerably longer to bake than one made with ingredients that are at room temperature. Also, the power setting will determine the cooking time.

## HOW CHARACTERISTICS OF FOODS AFFECT MICROWAVE COOKING

**Height of foods:** The upper portion of tall foods, particularly roasts, will cook more quickly than the lower portion. Therefore, it is wise to turn tall foods during cooking, sometimes several times.

**Density of foods:** Light, porous food such as cakes and breads cook more quickly than heavy, dense foods such as roasts and casseroles. You must take care when microwaving porous foods that the outer edges do not become dry and brittle. Shield edges with foil or microwave at a low power level.

## SPECIAL TECHNIQUES IN MICROWAVE COOKING

**Arranging and spacing:** Individual foods such as baked potatoes, cupcakes, and hors d'oeuvres will heat more evenly if placed in the oven an equal distance apart, preferably in a circular pattern. Never stack foods on top of one another.

**Stirring:** Stirring is one of the most important of all microwaving techniques. In conventional cooking, foods are stirred for the purpose of blending. Microwaved foods, however, are stirred in order to spread and redistribute heat. Always stir from the outside toward the centre, in order to distribute the heat as the outside of foods heats first.

**Turning over:** Large, tall foods such as roasts and whole chickens should be turned, so that the top and bottom will cook evenly. It is also a good idea to turn cut-up chicken and chops.

**Shielding:** Strips of aluminum foil, which block microwaves, are sometimes placed over the corners or edges of square and rectangular shaped foods to prevent those portions from overcooking. Never use too much foil, and make sure the foil is tightly secured to dish, or else you may cause "arcing".

**Elevating:** Thick or dense foods are often elevated so that microwaves can be absorbed by the underside and centre of the foods.

**Browning:** Meats and poultry that are cooked fifteen minutes or longer will brown lightly in their own fat. Foods that are cooked for a shorter period of time may be brushed with a browning sauce to achieve all appetizing color.

## UTENSILS

Never use metal or metal-trimmed utensils in your microwave oven. Microwaves cannot penetrate metal. They will bounce off any metal object in the oven — just as they bounce off the metal walls of the oven — and cause "arcing", a phenomenon that resembles lightning.

Most heat-resistant, non-metallic cooking utensils are safe for use in your microwave oven. However, some may contain materials that render them unsuitable as microwave cookware. If you have any doubts about a particular utensil, there's a simple way to find out if it can be used in your microwave oven.

**Testing utensils for microwave use:** Place the utensil in question next to a glass measure filled with water in the microwave oven.

Set the microwave at maximum power for 1 minute, if the water heats up, but the utensil remains cold to touch, the utensil is microwave-safe. However, if the water does not change temperature, but the utensil becomes warm, microwaves are being absorbed by the utensil and it is not safe for use in the microwave oven.

### **FACTORS AFFECTING COOKING TIMES**

**Starting Temperature:** The initial temperature of foods directly affects the length of time they must cook or heat. As in a conventional oven, frozen food takes longer to cook than does refrigerated food, while food at room temperature cooks most quickly.

**Moisture content of foods:** Since microwaves are attracted by moisture, relatively dry foods such as roasts and some vegetables should either be sprinkled with water prior to cooking or covered so as to retain steam.

**Size of foods:** The smaller and more uniform the pieces of food in the oven, the better. It is also a good idea to microwave cut-up foods in a roomy pan so that the microwaves can get to the pieces from all sides, thus ensuring even cooking.

**Quantity of foods:** The number of microwaves in your oven remains constant regardless of how much food is being cooked. Therefore, the more food you place in the oven, the longer the cooking time. Remember to decrease cooking times by at least one-third when halving a recipe.

**Bone and fat content of foods:** Bones conduct heat, and large amounts of fat attract microwave energy. Therefore, care must be taken when cooking bony or fatty cuts of meat that the meats do not cook unevenly and do not become overdone. Foods with a high fat and sugar content (Christmas puddings and mince pies, for instance) need careful timing, they can get very hot and burn easily — possibly even causing a fire in your oven.

**Shape of foods:** Microwaves penetrate only about 1 inch (2.5 cm) into foods the interior portion of thick foods is cooked as the heat generated on the outside travels inward. In other words, only the outer edge of any food is actually cooked by microwave energy the rest is cooked by convection. It follows then, that the worst possible shape for a food that is to be microwaved is a thick square: the corners will burn long before the centre is even warm. Round thin foods and ring-shaped foods microwave the most successfully.

### **COOK CHILL FOODS**

This type of food requires extra care when being prepared in a microwave. This is due to the fact that most package instructions are based on a certain oven. It is therefore important that you know the output power of your particular oven if your oven is of a lower wattage than that stated on the packet. Then adjustments to the cooking times will be required. INCREASE the cooking time in 1 minute and where possible stir each time then leave to stand for at least 3 minutes.

### **TIPS ON REHEATING FOOD**

- Arrange foods for reheating on the plate so that the thicker, denser and meatier portions are to the outer edge of the dish, where they will receive the maximum amount of energy, and the thinner areas to the centre where they will get less.
- When plating up meals for reheating, try to ensure that the food is arranged in an even layer.
- Cover foods when reheating with a layer of pricked cling film to retain moisture.
- When reheating, observe the standing time recommended in cooking procedures to make maximum use of the microwave energy and to prevent overcooking of the reheated dish.
- The times in the reheating chart refer to foods at room temperature. Allow extra time if the food is chilled.
- When reheating potatoes in their jackets, breads pastries or moist foods, place them on a sheet of absorbent kitchen paper so that it may absorb the moisture during the reheating time.
- Stir foods regularly during the reheating process. If stirring is not possible, then rotate the food or dish or re-arrange during the reheating time.

**THIS APPLIANCE SHOULD NOT BE USED FOR COMMERCIAL CATERING PURPOSES.**

# CARE OF YOUR MICROWAVE OVEN

---

## To Clean Your Oven

1. Keep the inside of the oven clean. Food spatters or spilled liquids stick to oven walls and between seal and door surface. It is best to wipe up spillovers with warm sudsy water and a soft cloth right away. Crumbs and spillovers will absorb the microwave energy and lengthen cooking time.

Use warm sudsy water and a soft cloth or sponge to wipe up crumbs that fall between the door and the frame. It is important to keep this area clean to assure a tight seal. Remove greasy spatters with warm sudsy water and a soft cloth or sponge. Then rinse and dry. Do not use harsh detergent or abrasive cleaners. The turntable can be washed by hand or in the dishwasher.

### CAUTION

**Abrasive cleansers, steel wool pads, gritty wash cloths, etc., can damage the control panel, and the interior and exterior oven surfaces. Use a soft cloth or a sponge with a mild detergent or spray glass cleaner.**

2. Keep the outside of the oven clean. Clean with soap and water then rinse with clean water and dry with a soft cloth or paper towel. To prevent damage to the operating parts inside the oven, the water should not be allowed to seep into the ventilation openings.

To clean control panel, open the door to prevent oven from accidentally starting, and wipe with a damp cloth followed immediately by a dry cloth. Touch clear pad after cleaning.

3. If steam accumulates inside or around the outside of the oven door, wipe with a soft cloth. This may occur when the microwave oven is operated under high humidity conditions and in no way indicates malfunction of the unit.

## SAFETY PRECAUTIONS

---

1. Do not attempt to tamper with, or make any adjustments or repairs to door, control panel, safety interlock switches or any other part of the oven. Repairs should be done by qualified service personnel only.
2. Do not hit or strike the control panel with objects such as silverware, utensils, etc. Breakage may occur.
3. Be careful when taking the cooking utensils out of the oven. Some dishes absorb heat from the cooked food and may be hot.  
Use hot pads. Microwave energy does not heat containers, but the hot food does.
4. Do not rinse cooking utensils by immediately placing them into water just after cooking. This may cause breakage. Allow the turntable to cool down before cleaning.

5. Do not use metal utensils for cooking. See "UTENSILS" section on page 18.
6. Starting a microwave oven when it's empty is not recommended. If you experiment, put a container of water in the oven.  
It is normal for the inside of the oven door to look wavy after the oven has been running for a while.
7. Do not heat unopened food containers in the oven. Pressure build-up can cause the container to burst, resulting in injury.
8. Do not use newspaper or other printed paper in the oven. Fire could result.  
Do not dry flowers, fruit, herbs, wood, paper, gourds or clothes in the oven. Fire could result.
9. Only use thermometers approved for microwave oven cooking.
10. Be certain the turntable is in place when you operate the oven.
11. Pierce the skin of potatoes, whole squash, apples or any fruit or vegetable which has a skin covering before cooking.  
Do not overcook potatoes. Fire could result. At the end of the recommended cooking time they should be slightly firm. Wrap in foil and set aside for 5 minutes. They will finish cooking while standing.
12. Never use your microwave oven to cook eggs in the shell or to cook or reheat a whole egg. Steam build-up may cause them to burst and burn you, and possibly damage the oven. Slice hard boiled eggs before heating. In rare instances, poached eggs have been known to explode. Cover poached eggs and allow a standing time of one minute before cutting into them.
13. Do not pop popcorn, except in a microwave approved popcorn popper or commercial package designed especially for microwave ovens.  
Never try to pop popcorn in a paper bag. Overcooking may result in smoke and fire.
14. Liquids heated in certain containers (especially cylindrical-shaped containers) may become overheated. The liquid may splash out with a loud noise during or after heating or when adding ingredients (coffee, etc.) resulting in harm to the oven and possible personal injury. For best results stir any liquid several times before heating or reheating.
15. Never lean on the door or allow a child to swing on it when the door is open. Injury could result.
16. Do not do canning of foods in the oven. Closed glass jars may explode resulting in damage to the oven or possible personal injury.
17. Do not use the oven to sterilize objects (baby bottles, etc.). It is difficult to maintain the high temperature required for safe sterilization.
18. Do not deep fry in the oven. Microwavable utensils are not suitable and it is difficult to maintain appropriate deep frying temperatures.
19. Do not use the oven for storage. Do not leave paper products, books or cooking utensils in the oven when not in use. Fire may result if someone accidentally starts the oven.
20. Do not let food or containers touch the top or sides of the oven.
21. If a fire should start in the oven cavity: do not open oven door; turn oven off; unplug the oven or turn off the power at the main power supply.
22. Do not place anything on top of the oven. Damage to the oven may result.
23. Do not try to melt paraffin wax in the oven. You may be burned.

# QUESTIONS AND ANSWERS

---

- Q. What's wrong when the oven light will not glow?
- A. There may be several reasons why the oven light will not glow.
- Door is not closed.
  - Light bulb is burned out.
  - START has not been touched.
- Q. Why is steam coming out of the air exhaust vent?
- A. Steam is normally produced during cooking operations. The microwave oven has been made to vent this steam out of the vent.
- Q. Does microwave energy pass through the viewing screen in the door?
- A. No. The holes, or ports are made to allow light to pass; they do not let microwave energy through.
- Q. Why does the beep tone sound when a pad on the Control Panel is touched?
- A. The beep tone sounds to assure that the setting is being properly entered.
- Q. Will the microwave oven be damaged if it operates empty?
- A. Yes. Never run it empty and without the turntable.
- Q. Why do eggs sometimes pop?
- A. When baking, frying, or poaching eggs, the yolk may pop due to steam build up inside the yolk membrane. To prevent this, simply pierce the yolk before cooking. Never microwave eggs in the shell.
- Q. Why is a standing time recommended after microwave cooking is over?
- A. After microwave cooking is finished, foods keep on cooking during standing time. This standing time finishes cooking evenly throughout the food. The amount of standing time depends on the density of the food.
- Q. Why doesn't my oven always cook as fast as the cookbook says it should?
- A. Check with your cookbook again to make sure you've followed directions exactly and to see what might cause variations in cooking time.
- Cookbook times and heat settings are suggestions, chosen to help prevent over-cooking . . . the most common problem in getting used to a microwave oven. Variations in the size, shape, weight and density of the food could require longer cooking time. Use your own judgment along with the cookbook suggestions to test for doneness, just as you would do with conventional cooking.
- Make sure the power level is at the recommended setting and that you are allowing for more time when cooking more food at one time.
- Also, the electric supply to your home or wall outlets may be low or lower than normal. Your electric company can tell you if the line voltage is low. Your electrician or service technician can tell you if the outlet voltage is low.
- Q. What should I do if the fan seems to be running slower than usual?
- A. The fan will run slower if the oven has been stored in a cold area. Let the oven warm up to normal room temperature.
- Q. What should I do if the microwave oven will not run?
- A. Make sure you touched START and that the door is firmly closed and latched. Check to see if you have set Delay Start.
- Q. What should I do if nothing operates?
- A. Check to make sure the power supply cord is plugged into a live circuit with the proper voltage. Also check your home's main fuses or circuit breaker box. Check your electric company for a power failure.

# OTHER HELPFUL INSTRUCTIONS

---

For best results and more enjoyable cooking, please read this manual thoroughly.

## **For Best Results:**

1. When determining the time for a particular food, begin by using minimum time and checking occasionally for doneness.  
The microwave oven cooks so quickly, it is easy to overcook foods.
2. Small quantities of food, or foods with low water content may dry out and become hard if cooked too long.
3. Do not use the oven for drying kitchen towels or paper products. They may burn.
4. Don't cook eggs, in their shell, in the microwave oven.
5. For food items such as apples, potatoes, egg yolks, chicken livers, etc., be sure to pierce the skin or membrane to prevent bursting of the food while cooking in the oven.

## **Defrosting Frozen Foods:**

1. Foods that have been frozen can be placed directly in the oven for thawing. (Be certain to remove any metallic ties or wraps.)
2. Defrost according to the Defrost Charts found in a reliable cookbook.
3. For areas of the food thawing faster than others, cover with small pieces of aluminium foil. This helps slow down or stop the defrosting process.
4. Some foods should not be completely thawed before cooking. For example, fish cooks so quickly that it is sometimes better to begin cooking while still slightly frozen.
5. It may be necessary to increase or decrease the cooking time in some recipes, depending on the starting temperature of the foods.

**NOTE:** Air from the vent may become warm during cooking. This is normal.

# TECHNICAL SPECIFICATIONS

---

Power Input	: 120V, 60Hz, 12.5A AC only, 3-prong grounded plug
Power Output	: 750 Watts (Max.)
Microwave Frequency	: 2,450 MHz
Outer Dimensions	: 22 <sup>3</sup> / <sub>4</sub> "(W)×13 <sup>1</sup> / <sub>2</sub> "(H)×16 <sup>7</sup> / <sub>16</sub> "(D) mm
Cavity Dimensions	: 15 <sup>3</sup> / <sub>8</sub> "×10 <sup>7</sup> / <sub>16</sub> "×15"(D) mm
Cavity Volume	: 1.4 Cu-ft.
Net Weight	: 40 lbs. (Approx.)
Shipping Weight	: 45 lbs. (Approx.)
Rated Power Consumption	: 1400 Watts

Weights and dimensions shown are approximate.  
Specifications are subject to change without notice.

The serial number is found on the back of this unit. This number is unique to this unit and not available to others. You should record requested information here and retain this guide as a permanent record of your purchase.	<u>Data of Purchase</u> _____
	<u>Dealer Purchased From</u> _____
	<u>Dealer Address</u> _____ _____
	<u>Dealer Phone No.</u> _____
	<u>Model No.</u> MFE 14XW _____
	<u>Serial No.</u> _____



*THIS PAGE  
INTENTIONALLY LEFT  
BLANK*

# LIMITED WARRANTY

# ROPER

## Appliances

LENGTH OF WARRANTY (From date of purchase)	PRODUCTS COVERED	WHAT WE WILL PAY FOR
<b>FULL ONE YEAR WARRANTY</b>	All Roper Appliances	Replacement parts and repair labor to correct defects in materials or workmanship.
<b>FULL FIVE YEAR WARRANTY</b>	Refrigerators Freezers Air Conditioners	Replacement parts and repair labor for the sealed refrigeration system (compressor, evaporator, condenser, drier or connecting tubing) which we find to be defective in materials or workmanship.
<b>LIMITED 2ND-5TH YEAR WARRANTY</b>	Microwave Ovens	Repair or replacement of magnetron tube which we find to be defective in materials or workmanship.
<b>LIMITED 2ND-5TH YEAR WARRANTY</b>	Automatic Washers	Repair or replacement of any part of the gear case assembly which we find to be defective in materials or workmanship.

### WHAT WE WILL NOT PAY FOR

**A. SERVICE CALLS TO:**

1. Correct the installation of your appliance.
2. Instruct you how to use your appliance.
3. Replace house fuses or correct house wiring or plumbing.
4. Replace owner accessible light bulbs.

**B. Repairs when appliance is used in other than normal, single-family household use.**

**C. Pick up and delivery. Your appliance is designed to be repaired in the home.**

**D. Damage to appliance caused by accident, misuse, fire, flood, acts of God, or use of product not approved by use.**

**E. Any labor costs during the limited warranties.**

This Roper appliance is warranted by Whirlpool Corporation. Under no circumstances shall it be liable under this warranty for incidental or consequential damages and all implied warranties are limited to the same time periods stated in the express warranties for Roper Brand Appliances. Some states do not allow the exclusion or limitation of incidental or consequential damages or limitations of how long an implied warranty may last, so the above limitations or exclusions may not apply to you.

This warranty gives you specific legal rights, and you may also have other rights which vary from state to state.

Outside the United States, a different warranty may apply. For details, please contact your franchised Roper distributor or military exchange.

### HOW TO GET SERVICE OR ASSISTANCE

If you need service, first see the "Before You Call For Service" section of this book. If you still need service after checking this section additional help can be found if you:

- Contact your selling dealer for the authorized servicer in your area:  
OR
  - Phone 1-800-44-ROPER (1-800-447-6737) between 8:00 a.m. and 4:30 p.m. Eastern Time, Monday through Friday\*.  
OR
  - For further information write to: Consumer Relations Dept., Roper Brand Appliances, 2000 M-63 North, Benton Harbor, MI 49022.\*
- \* When requesting assistance, please provide the model and serial numbers, date of purchase, and a complete description of the problem.  
The model and serial numbers are located on back of unit.

If you are not satisfied with the service received, contact the Major Appliance Consumer Action Panel (MACAP). MACAP is a group of independent consumer experts that voices consumer views at the highest levels of the major appliance industry.

Contact MACAP only when the dealer, authorized servicer or Roper Brand Appliance warrantor have failed to resolve your problem:

Major Appliance Consumer Action panel  
20 North Wacker Drive  
Chicago, IL 60606

MACAP will in turn inform us of your action.

Part No. 4B74834B/4158665

© 1990 Whirlpool Corporation

Printed in Korea